

METLOR[®]
puro calor

CATÁLOGO
22 | 23

V.09

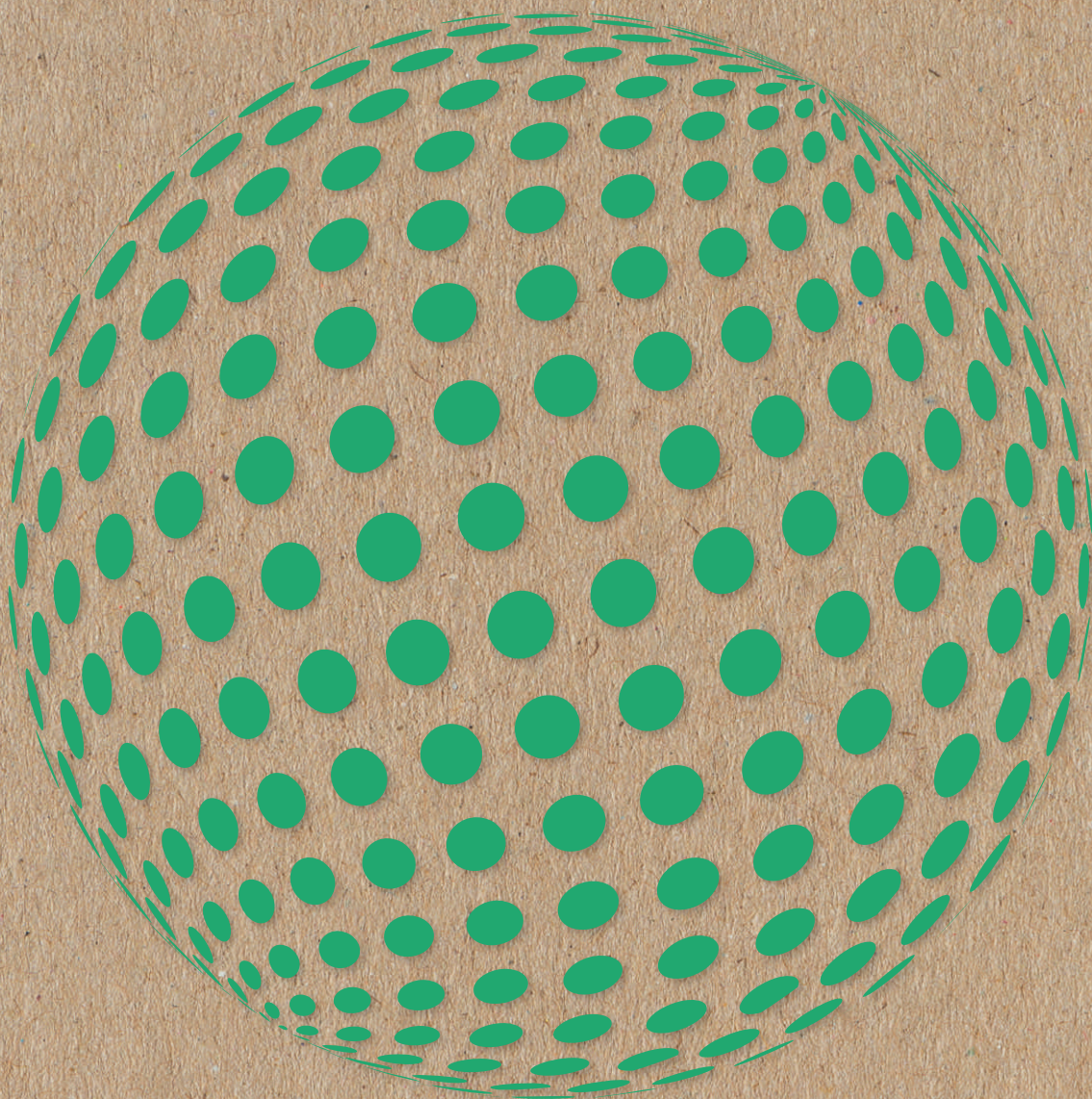

Soluções Globais de Aquecimento

Soluciones Globales para Calefacción

metlor.com



A METLOR é uma marca registada da Metalúrgica do Eucalipto Lda.

A empresa tem a sua origem em 1970 enquanto empresa em nome individual e em outro sector de actividade, com o decorrer dos anos a aposta centrou-se sobretudo no desenvolvimento de soluções para aquecimentos a biomassa:

- Salamandras a pellets;
- Salamandras a lenha;
- Recuperadores de calor de ar quente;
- Recuperadores de aquecimento central;
- Fogões a lenha;
- Caldeiras a lenha e a pellets.

Em 2009 foi constituída a empresa sob a forma jurídica actual, dispondo neste momento de 60 colaboradores.

Com uma quota de mercado português estimada de 25%, mercê da colocação anual no mercado de 20.000 soluções de aquecimento, a empresa encontra-se em processo de internacionalização com a representação em importantes mercados tais como em Espanha, França, Polónia, Grécia e América Latina para citar os mais importantes.

Distinguida com os seguintes galardões:



- **Kit cordão e cola**
Kit de cable y pegamento

- **Silicone**
Silicona

- **Produto de limpeza para Vidros**
Limpiador de vidro

- **Creme de polimento**
Crema de pulido

- **Limpa Chaminés**
Deshollinadores

- **Tubo de cola**
Tubo de pegamento

METLOR es una marca comercial registrada de Metalúrgica do Eucalipto Lda.

La compañía tiene su origen en 1970 como una empresa unipersonal y con otra actividad productiva. En los últimos años nuestra apuesta se ha centrado en el desarrollo de soluciones para la calefacción por biomasa:

- Estufas a pellets;
- Estufas a leña;
- Insertables a leña con producción de aire caliente;
- Insertables a leña hidro-calefactores;
- Cocinas a leña;
- Calderas a pellets.

En 2009 la empresa fue constituida bajo la forma jurídica actual, contando actualmente con mas de 60 puestos de trabajo directos.

En este momento poseemos una cuota superior al 25% del mercado portugués, como consecuencia de la producción de mas de 20.000 máquinas por año y continuamos creciendo en diferentes mercados externos tales como España, Francia, Polonia, Grecia o Brasil.

ACESSÓRIOS | ACCESORIOS

Utilize produtos certificados Metlor
Use productos con certificación Metlor



EcoDesign | PT

No âmbito da sustentabilidade ambiental e ecológica, foi criado pela Comissão Europeia um conjunto de Regulamentos que define os requisitos de conceção ecológica e rotulagem energética dos aquecedores de ambiente local e caldeiras a combustível sólido. Os requisitos para a conceção ecológica definem valores mínimos para a eficiência energética e limites máximos para as emissões de partículas em suspensão (PM), compostos orgânicos gasosos (COG), monóxido de carbono (CO) e óxidos de azoto (NOx). O objetivo da conceção ecológica é reduzir significativamente as emissões dos aquecedores e promover poupanças anuais de energia até o ano 2030.

REGULAMENTO DELEGADO (UE) 2015/1186 DA COMISSÃO de 24 de abril de 2015 que complementa a Diretiva 2010/30/UE do Parlamento Europeu e do Conselho no que respeita à rotulagem energética dos aquecedores de ambiente local.

REGULAMENTO DELEGADO (UE) 2015/1187 DA COMISSÃO de 27 de abril de 2015 que complementa a Diretiva 2010/30/UE do Parlamento Europeu e do Conselho no que respeita à rotulagem energética das caldeiras a combustível sólido e dos sistemas mistos compostos por uma caldeira a combustível sólido, aquecedores complementares, dispositivos de controlo da temperatura e dispositivos solares.

REGULAMENTO (UE) 2015/1185 DA COMISSÃO de 24 de abril de 2015 que dá execução à Diretiva 2009/125/CE do Parlamento Europeu e do Conselho no que respeita aos requisitos de conceção ecológica para os aquecedores de ambiente local a combustível sólido.

REGULAMENTO (UE) 2015/1189 DA COMISSÃO de 28 de abril de 2015 que dá execução à Diretiva 2009/125/CE do Parlamento Europeu e do Conselho no que respeita aos requisitos de conceção ecológica para as caldeiras a combustível sólido. para as caldeiras a combustível sólido.

EcoDesign | ESP

En el contexto de la sostenibilidad ambiental y ecológica, la Comisión Europea creó un conjunto de Normativa que define los requisitos de diseño ecológico y etiquetado energético para aparatos de calefacción local y calderas de combustible sólido. Los requisitos de ecodiseño definen valores mínimos de eficiencia energética y límites máximos de emisiones de material particulado (PM), compuestos orgánicos gaseosos (COG), monóxido de carbono (CO) y óxidos de nitrógeno (NOx).

El objetivo del ecodiseño es reducir significativamente las emisiones de los calefactores y promover ahorro anual de energía para el año 2030.

REGLAMENTO DELEGADO (UE) 2015/1186 DE LA COMISIÓN, de 24 de abril de 2015, por el que se Directiva 2010/30/UE del Parlamento Europeo y del Consejo sobre el etiquetado energético de calentadores de espacio locales.

REGLAMENTO DELEGADO (UE) 2015/1187 DE LA COMISIÓN, de 27 de abril de 2015, por el que se Directiva 2010/30/UE del Parlamento Europeo y del Consejo sobre el etiquetado energético de calderas de combustible sólido y sistemas mixtos que comprenden una caldera de combustible sólido, calentadores complementarios, dispositivos de control de temperatura y dispositivos solares.

REGLAMENTO (UE) 2015/1185 DE LA COMISIÓN de 24 de abril de 2015 por el que se desarrolla la Directiva 2009/125/CE del Parlamento Europeo y del Consejo en relación con los requisitos de diseño ecológico para calentadores locales de combustible sólido.

REGLAMENTO (UE) 2015/1189 DE LA COMISIÓN de 28 de abril de 2015 por el que se desarrolla la Directiva 2009/125/CE del Parlamento Europeo y del Consejo en relación con los requisitos de diseño ecológico para calderas de combustibles sólidos.para calderas de combustibles sólidos.

ÍNDICE

Índice

RECUPERADORES A LENHA

Insertables a leña

- P. 03 **Ar Quente com Ventilação**
Insertables aire caliente con ventilación
- P. 08 **Recuperadores de Calor**
Insertables aire caliente
- P. 10 **P/ Aquecimento Central**
Insertables hidro calefactoras

SALAMANDRAS A LENHA

Estufas a leña

- P. 16 **Com ventilação**
Con ventilación
- P. 19 **Sem ventilação**
Sin ventilación

RECUPERADORES A PELLETS

Insertables a pellets

- P. 24 **Ar Quente com ventilação**
Aire caliente con ventilación
- P. 28 **P/ Aquecimento Central**
Insertables hidro calefactores
- P. 30 **Ar Quente e p/ Aquecimento Central**
Insertables aire caliente e hidro calefactores

SALAMANDRAS A PELLETS

Estufas a pellets

- P. 32 **Ar Quente**
TAire caliente
- P. 38 **Hidroestufas**
Hidro-estufas - agua+aire

CALDEIRAS

Calderas

- P. 40 **A Pellets**
A Pellets
- P. 50 **Policombustível**
Policombustibel
- P. 52 **A Lenha**
A Leña

FOGÕES

Cocinas

- P. 54 **Tradicionais**
Tradicionales



Nota prévia | Prefácio

Nota Previa

As características dos artigos constantes deste catálogo podem ser alteradas sem aviso prévio sempre que tal se justifique.
Las características de los artículos en este catálogo pueden cambiar sin previo aviso siempre que sea apropiado.

Os Produtos Metlor são distinguidos por seguirem as seguintes normas Portuguesas e Europeias

Los productos Metlor se distinguen por cumplir las siguientes normas portuguesas y europeas

Caldeiras domésticas independentes que utilizam combustíveis sólidos com potência térmica nominal inferior ou igual a 50 kW

Calderas domésticas independientes que utilizan combustibles sólidos con potencia térmica nominal inferior o igual a 50 kW

NORMA EUROPEIA: EN 12809:2001 | EN 12809:2001/A1:2004 | EN 12809:2001/AC:2006 | EN 12809:2001/A1:2004/AC:2007
NORMA PORTUGUESA: NP EN 12809:2015

Fogões de cozinha domésticos a combustíveis sólidos

Cocinas domésticas a combustibles sólidos

NORMA EUROPEIA: EN 12815:2001 | EN 12815:2001/A1:2004 | EN 12815:2001/AC:2006 | EN 12815:2001/A1:2004/AC:2007
NORMA PORTUGUESA: NP EN 12815:2014 (Publicada Emenda A1:2015)
EN 12815:2004/A1:2005

Aparelhos de encastrar, incluindo lareiras, que utilizam combustíveis sólidos

Aparatos de encastrar, incluidas chimeneas, que utilizan combustibles sólidos

NORMA EUROPEIA: EN 13229:2001 | EN 13229:2001/A1:2003 | EN 13229:2001/A2:2004 | EN 13229:2001/AC:2006 | EN 13229:2001/A2:2004/AC:2007

Aparelhos para aquecimento ambiente que utilizam combustíveis sólidos

Aparatos de calefacción de ambiente que utilizan combustibles sólidos

NORMA EUROPEIA: EN 13240:2001 | EN 13240:2001/A2:2004 | EN 13240:2001/AC:2006 | EN 13240:2001/A2:2004/AC:2007
NORMA PORTUGUESA: NP EN 13240:2015 | EN 13240:2001/A2:2005

Aparelhos domésticos de aquecimento ambiente que utilizam granulados de madeira

Aparatos domésticos de calefacción ambiente que utilizan granulados de madera

NORMA EUROPEIA: EN 14785:2006 | EN 13240:2001/A2:2004 | EN 13240:2001/AC:2006 | EN 13240:2001/A2:2004/AC:2007
NORMA PORTUGUESA: NP EN 13240:2015

CARACTERÍSTICAS

Icones



Alimentação Electrica

Electric power supply
Alimentación eléctrica



Altura - Largura - Profundidade

Height - Width - Depth
Altura - Ancho - Fondo



Área Aquecida m3

Heated area
Área calefactable

Os valores mencionados na área de aquecimento tem como referência 40W/m3 ou 110W/m2 a 2,5m de altura.

The values mentioned in the heating area are based on 40W/m3 or 110W/m2 at 2.5m height.

Los valores mencionados en el área de calefacción se basen en 40W/m3 o 110W/m2 con una altura de 2,5m.



Capacidade Max. do Silo

Max. pellets load
Cap. max. del silo



Comprimento Máx. da Lenha

Length max. Firewood
Longitud max leña



Controle Remoto - Opcional

Remot control - Optional
Mando a distancia - Opcional



Combustível

Fuel
Combustible



Dimensão do Vidro (A x L x P)

glass dimension
dimensión de vidrio



Eficiência %

Efficiency %
Eficiencia %



Emissão de CO (%) (13% O2)

CO emissions (%) (13% O2)
Emisión CO (%) (13% O2)



Entrada de Ar Exterior

Air inlet outside
Entrada de aire exterior



Min|Max Consumo de Combustível por h

Min|Max fuel consumption per h
Min|Max consumo combustible



Min|Max Consumo de Energia

Min|Max power consumption
Min|Max consumo eléctrico



Nível de Ruído

Noise level
Nive de ruido



Peso

Weight
Peso



Potência Libertada para Ambiente

Power released to the environment
Potencia al ambiente



Potência Máxima

Maximum capacity
Potencia máxima



Potência Nominal

Power heat
Potencia útil



Pressão

Pressure
Presión



Pressão da Chaminé PA

The chimney drft
Presión conducto chimenea



Saída de Exaustão de Fumos

Fume exhaust outlet
Salida de humos



NOx | COV | Partículas

NOx | COV | Partículas
NOx | COV | Particles



Temperatura Ambiente de Trabalho

Working environment temperature
Temperatura ambiente de trabajo



Temperatura Máx da Água

Max water temperature
Temperatura max agua



Temperatura Máx de Saida de Gases

Max temperature of the flue gas
Temperatura max salida humos



Ventilação

Ventilation
Ventilación



Volume de água

Volume Water
Volúmen de agua



Wi-fi

Feeder
Transmisor Wi-fi

RECUPERADORES AR QUENTE C/ VENTILAÇÃO LENHA

Insertables a leña con produccion de aire caliente

A+

ELOS ECOLUX 70

540 x 700 x 470 mm		8,5 Kw	
87,7 %		150 mm	
110 52 25 mg/m3		12 Pa	
0,08		114 kg	
200 m³/h		450 mm	

ELOS ECOLUX 80

540 x 800 x 470 mm		9,5 Kw	
88,9 %		150 mm	
106 53 25 mg/m3		12 Pa	
0,093		127 kg	
200 m³/h		600 mm	



ENTRADA DE AR EXTERIOR
Entrada de Aire Exterior

EAN 5600863301686



ENTRADA DE AR EXTERIOR
Entrada de Aire Exterior

EAN 5600863301693



ELOS ECOLUX 80













Nota: Fabricado em aço de 4mm, pintura com tinta especializada para equipamentos de temperatura elevada até 600°C, vidro Neocerâmico de 4mm de espessura e com uma amplitude térmica até 900°C, interior revestido a cerâmico refratário. Dupla combustão.

Nota: Fabricado en chapa de acero carbono con un espesor de 5mm, pintura especial que soporta una temperatura elevada hasta 600°C para equipos de alta temperatura hasta 600°C, Cristal Neocerámico de 4mm de espesor y con una amplitud térmica de hasta 900°C, interior en vermiculita de 20mm espesor y una densidade de 750Kg/m3.

RECUPERADORES AR QUENTE C/ VENTILAÇÃO LENHA

Insertables a leña con produccion de aire caliente

ELOS 70 a)

- 570 x 700 x 425 mm 
- 7,8 kW 
- 80,7% 
- 112 | 85 | 36 mg/m³ 
- 0,085 
- 150 mm 
- 12 Pa 
- 200 m³/h 
- 110kg 
- 450 mm 



A+









EAN 5600863307404



MEDIDA DA CAIXA | Medidas de la caja sin el frente: 550 x 675 x 395 mm

ENTRADA DE AR EXTERIOR | Entrada de Aire Exterior 

ELOS 70 VITRUS a)

- 570 x 700 x 425 mm 
- 7,8 kW 
- 80,7% 
- 112 | 85 | 36 mg/m³ 
- 0,085 
- 150 mm 
- 12 Pa 
- 200 m³/h 
- 110 kg 
- 450 mm 



A+





EAN 5600863307411



MEDIDA DA CAIXA | Medidas de la caja sin el frente: 550 x 675 x 395 mm

ENTRADA DE AR EXTERIOR | Entrada de Aire Exterior 

ELOS 98 b)

- 595 x 983 x 440 mm 
- 10,2 kW 
- 82,3% 
- 183 | 22 | 17 mg/m³ 
- 0,117 
- 180 mm 
- 12 Pa 
- 300 m³/h 
- 130 kg 
- 750 mm 



A+

EAN 5600863303215



MEDIDA DA CAIXA | Medidas de la caja sin el frente: 575 x 958 x 410 mm

ENTRADA DE AR EXTERIOR | Entrada de Aire Exterior 

Nota: Fabricado em aço de 4mm, pintura com tinta especializada para equipamentos de temperatura elevada até 600°C, vidro Neocerâmico de 4mm de espessura e com uma amplitude térmica até 900°C, interior revestido a vermiculite com 20mm de espessura e uma densidade de 750g/m³. Dupla combustão.

Nota: Fabricado en chapa de acero carbono con un espesor de 5mm, pintura especial que soporta una temperatura elevada hasta 600°C para equipos de alta temperatura hasta 600°C, Cristal Neocerámico de 4mm de espesor y con una amplitud térmica de hasta 900°C, interior en vermiculita de 20mm espesor y una densidade de 750Kg/m³.

a) Equipado com 1 ventilador tangencial com controlo de velocidade e termoclick.

b) Equipado con 1 ventilador tangencial con control de velocidad y termoclick.

b) Equipado com 2 ventilador tangenciais com controlo de velocidade e termoclick.

b) Equipado con 2 ventiladores tangenciales con control de velocidad y termoclick.

RECUPERADORES AR QUENTE C/ VENTILAÇÃO LENHA

Insertables a leña con producción de aire caliente



ELOS 98 VITRUS ^{b)}

- 595 x 983 x 440 mm
- 10,2 kW
- 82,3%
- 183 | 22 | 17 mg/m3
- 0,117
- 180 mm
- 12 Pa
- 300 m³/h
- 130 kg
- 750 mm

MEDIDA DA CAIXA | Medidas de la caja sin el frente: 575 x 958 x 410 mm

ENTRADA DE AR EXTERIOR | Entrada de Aire Exterior



R8A ^{c)}

- 545 x 685 x 440 mm
- 7,8 kW
- 80,7%
- 112 | 85 | 36 mg/m3
- 0,085
- 150 mm
- 12 Pa
- 132 m³
- 100 kg
- 540 mm

MEDIDA DA CAIXA | Medidas de la caja sin el frente: 528 x 660 x 395 mm

ENTRADA DE AR EXTERIOR | Entrada de Aire Exterior



R7A ^{c)}

- 540 x 600 x 440 mm
- 6,5 kW
- 75,3%
- 114 | 70 | 29 mg/m3
- 0,101
- 150 mm
- 12 Pa
- 132 m³
- 85 kg
- 450 mm

MEDIDA DA CAIXA | Medidas de la caja sin el frente: 535 x 565 x 385 mm

ENTRADA DE AR EXTERIOR | Entrada de Aire Exterior

Nota: Fabricado em aço de 4mm, pintura com tinta especializada para equipamentos de temperatura elevada até 600°C, vidro Neocerâmico de 4mm de espessura e com uma amplitude térmica até 900°C, interior revestido a vermiculite com 20mm de espessura e uma densidade de 750g/m3. Dupla combustão.

Nota: Fabricado en chapa de acero carbono con un espesor de 5mm, pintura especial que soporta una temperatura elevada hasta 600°C para equipos de alta temperatura hasta 600°C, Cristal Neocerámico de 4mm de espesor y con una amplitud térmica de hasta 900°C, interior en vermiculita de 20mm espesor y una densidade de 750Kg/m3.

b) Equipado com 2 ventilador tangenciais com controlo de velocidade e termoclick.

b) Equipado con 2 ventiladores tangenciales con control de velocidad y termoclick.











c) Equipado com 2 ventiladores 90x90mm acionados por termostato a +- 50°C

c) Equipado con 2 ventiladores 90x90 programados con termostato a +- 50°C

RECUPERADORES AR QUENTE C/ VENTILAÇÃO LENHA

Insertables a leña con producción de aire caliente

ELOS 60 a)









- 540 x 600 x 430 mm 
- 6,5 kW 
- 75,3 % 
- 114 | 70 | 29 mg/m³ 
- 0,101 
- 150 mm 
- 12 Pa 
- 132 m³/h 
- 100 kg 
- 420 mm 



MEDIDA DA CAIXA | Medidas de la caja sin el frente: 530 x 575 x 400 mm

ENTRADA DE AR EXTERIOR | Entrada de Aire Exterior 

ELOS 60 VITRUS a)

- 540 x 600 x 430 mm 
- 6,5 kW 
- 75,3 % 
- 114 | 70 | 29 mg/m³ 
- 0,101 
- 150 mm 
- 12 Pa 
- 132 m³/h 
- 100 kg 
- 420 mm 



MEDIDA DA CAIXA | Medidas de la caja sin el frente: 530 x 575 x 400 mm

ENTRADA DE AR EXTERIOR | Entrada de Aire Exterior 

Nota: Fabricado em aço de 4mm, pintura com tinta especializada para equipamentos de temperatura elevada até 600°C, vidro Neocerâmico de 4mm de espessura e com uma amplitude térmica até 900°C, interior revestido a vermiculite com 20mm de espessura e uma densidade de 750g/m³. Dupla combustão.

Nota: Fabricado en chapa de acero carbono con un espesor de 5mm, pintura especial que soporta una temperatura elevada hasta 600°C para equipos de alta temperatura hasta 600°C, Cristal Neocerámico de 4mm de espesor y con una amplitud térmica de hasta 900°C, interior en vermiculita de 20mm espesor y una densidad de 750Kg/m³.

- a) Equipado com 1 ventilador tangencial com controlo de velocidade e termoclick.
- b) Equipado con 1 ventilador tangencial con control de velocidad y termoclick.

RECUPERADORES AR QUENTE C/ VENTILAÇÃO LENHA

Insertables a leña con producción de aire caliente



VITRUS 75 c)

- 560 x 750 x 430 mm
- 7,8 kW
- 80,7%
- 112 | 85 | 36 mg/m³
- 0,085
- 150 mm
- 12 Pa
- 190 m³/h
- 110kg
- 450 mm

MEDIDA DA CAIXA | Medidas de la caja sin el frente: 545 x 730 x 395 mm

ENTRADA DE AR EXTERIOR | Entrada de Aire Exterior ✓

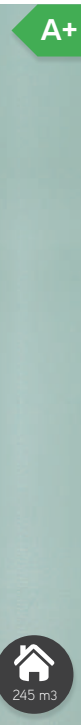
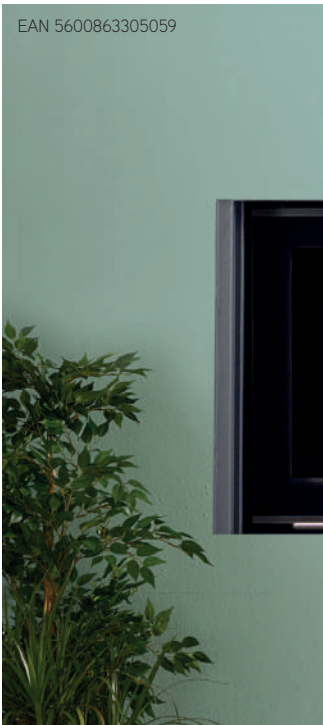

VITRUS UP b)

- 595 x 983 x 605 mm
- 10,2 kW
- 82,3%
- 183 | 22 | 17 mg/m³
- 0,117
- 180 mm
- 12 Pa
- 300 m³/h
- 200 kg
- 750 mm

SUBIDA VERTICAL | Ascenso Vertical

ENTRADA DE AR EXTERIOR | Entrada de Aire Exterior ✓

Nota: Fabricado em aço de 4mm, pintura com tinta especializada para equipamentos de temperatura elevada até 600°C, vidro Neocerâmico de 4mm de espessura e com uma amplitude térmica até 900°C, interior revestido a vermiculite com 20mm de espessura e uma densidade de 750g/m³. Dupla combustão.

Nota: Fabricado en chapa de acero carbono con un espesor de 5mm, pintura especial que soporta una temperatura elevada hasta 600°C para equipos de alta temperatura hasta 600°C, Cristal Neocerámico de 4mm de espesor y con una amplitud térmica de hasta 900°C, interior en vermiculita de 20mm espesor y una densidade de 750Kg/m³.

a) Equipado com 1 ventilador tangencial com controlo de velocidade e termoclick.

b) Equipado con 1 ventilador tangencial con control de velocidad y termoclick.

c) Equipado com 2 ventiladores 90x90mm acionados por termostato a +- 50°C

c) Equipado con 2 ventiladores 90x90 programados con termostato a +- 50°C

RECUPERADORES DE CALOR A LENHA

Insertables aire caliente a leña



COLEÇÃO
TRI-DESIGN
by Metlor

ECOLUX 120 UP

A+

- 1760 x 1503 x 690 mm
- 25 kW
- 80 %
- 104 | 50 | 28 mg/m³
- 0,097
- 250 mm
- 12 Pa
- 1200 x 430 mm
- 610 m³
- 431 kg



EAN 5600863301778

610 m³

ENTRADA DE AR EXTERIOR | Entrada de Aire Exterior

TRI PANORÂMICO

A

- 1895 x 847 x 577 mm
- 12 kW
- 78 %
- 82 | 39 | 35 mg/m³
- 0,063
- 200 mm
- 12 Pa
- 530 x 800 x 350 mm
- 290 m³
- 324 kg



EAN 5600863301679

290 m³

ENTRADA DE AR EXTERIOR | Entrada de Aire Exterior

Nota: Estes Recuperadores de Calor a Lenha fazem parte da Coleção Premium da Metlor e caracterizam-se pela sua prática abertura vertical (tipo guilhotina), para uma utilização mais cómoda, contando ainda com uma abertura na lateral, que facilita uma melhor limpeza e manutenção.

Nota: Estas Estufas de Lenha forman parte de la Colección Premium de Metlor y se caracterizan por su práctica abertura vertical (tipo guillotina), para un uso más cómodo, con una abertura lateral, que facilita una mejor limpieza y mantenimiento.



RECUPERADORES DE CALOR A LENHA

Insertables aire caliente a leña

COLEÇÃO
TRI-DESIGN
by Metlor

(ESQ.) EAN 5600863301709
(DRT.) EAN 5600863301716



A+

TRI QUINA

- 1231 x 904 x 655 mm
- 14 kW
- 83 %
- 94 | 25 | 32 mg/m³
- 0,068
- 200 mm
- 12 Pa
- 430 x 680 x 375 mm
- 340 m³
- 215 kg



NOTA

Disponível com o vidro lateral à direita

ENTRADA DE AR EXTERIOR | Entrada de Aire Exterior

EAN 5600863301655



A

TRI AVANT

- 1895 x 1027 x 582 mm
- 12 kW
- 78 %
- 98 | 69 | 38 mg/m³
- 0,091
- 200 mm
- 12 Pa
- 530 x 540 x 800 mm
- 290 m³
- 384 kg



ENTRADA DE AR EXTERIOR | Entrada de Aire Exterior

Nota: Estes Recuperadores de Calor a Lenha fazem parte da Coleção Premium da Metlor e caracterizam-se pela sua prática abertura vertical (tipo guilhotina), para uma utilização mais cómoda, contando ainda com uma abertura na lateral, que facilita uma melhor limpeza e manutenção.

Nota: Estas Estufas de Lenha formam parte de la Colección Premium de Metlor y se caracterizan por su práctica abertura vertical (tipo guillotina), para un uso más cómodo, con una abertura lateral, que facilita una mejor limpieza y mantenimiento.



LLAR S ECO

586 x 750 x 580 mm	75 %
16,4 kW	200 mm
7,5 kW	165 kg
21 L	4950 gr/h
115 109 16 mg/m ³	0,08
12 Pa	500 mm
A	400 m ³

EAN 5600863306971

LLAR L ECO

570 x 750 x 580 mm	80,3 %
17,12 kW	200 mm
10,4 kW	210 kg
50 L	4730 gr/h
81 65 35 mg/m ³	0,111
12 Pa	500 mm
A+	420 m ³

EAN 5600863303246

LLAR XL ECO PLUS

676 x 828 x 580 mm	80,2 %
25,06 kW	200 mm
16,03 kW	250 kg
70 L	6930 gr/h
79 22 35 mg/m ³	0,10
12 Pa	500 mm
A+	615 m ³

EAN 5600863307497

RECUPERADORES AQ.CENTRAL A LENHA

Insertables hidro-calefactores a leña

LLAR L ECO





LLAR S VITRUS

586 x 750 x 580 mm	75 %
16,4 kW	200 mm
7,5 kW	165 kg
21 L	4950 gr/h
115 109 16 mg/m ³	0,08
12 Pa	500 mm
A	400 m ³

EAN 5600863306551

LLAR L VITRUS

570 x 750 x 580 mm	80,3 %
17,12 kW	200 mm
10,4 kW	210 kg
50 L	4730 gr/h
81 65 35 mg/m ³	0,111
12 Pa	500 mm
A+	420 m ³

EAN 5600863303239

LLAR XL VITRUS PLUS

676 x 828 x 580 mm	80,2 %
25,06 kW	200 mm
16,03 kW	250 kg
70 L	6930 gr/h
79 22 35 mg/m ³	0,10
12 Pa	500 mm
A+	615 m ³

EAN 5600863306988

RECUPERADORES AQ.CENTRAL A LENHA















Insertables hidro-calefactores a leña

LLAR L





LLAR LDA

 570 x 750 x 519 mm	 80,3 %
 17,12 kW	 200 mm
 10,4 kW	 200 kg
 50 L	 4730 gr/h
 81 65 35 mg/m ³	 0,111
 12 Pa	 500 mm
 A+	 420 m ³

EAN 5600863303253



RECUPERADORES AQ.CENTRAL A LENHA

Insertables hidro-calefactores a leña

LLAR LDA





BELL 11 (*)

 925 x 795 x 460 mm	 78,2 %
 8,3 kW	 150 mm
 200 m ³	 120 kg
 145 57 33 mg/m ³	 0,060
 12 Pa	 550 mm



ENTRADA DE AR EXTERIOR | Entrada de Aire Exterior 

(*) Produto sujeito a alterações
Producto sujeto a cambios

EAN 5600863303673



SALAMANDRAS A LENHA VENTILADAS

Estufas a leña con ventilación



BELL 11



SALAMANDRAS A LENHA VENTILADAS

Estufas a lenha con ventilación

SR895

- 810 x 477 x 376 mm 
- 5,5 kW 
- 83,9% 
- 152 | 24 | 35 mg/m³ 
- 0,041 
- 120 mm 
- 12 Pa 
- 83 kg 
- 340 m³ 
- 320 mm 











(*) Produto sujeito a alterações
Producto sujeto a cambios



ENTRADA DE AR EXTERIOR | Entrada de Aire Exterior 

SR910

(canto/ rincón)

- 806 x 595 x 605 mm 
- 6 kW 
- 82,3% 
- 98 | 116 | 21 mg/m³ 
- 0,063 
- 120 mm 
- 12 Pa 
- 89 kg 
- 340 m³ 
- 320 mm 

(*) Produto sujeito a alterações
Producto sujeto a cambios



ENTRADA DE AR EXTERIOR | Entrada de Aire Exterior 

SALAMANDRAS A LENHA SEM VENTILAÇÃO

Estufas a lenha sin ventilación

A



700 x 750 x 370 mm



120 mm



145 | 57 | 33 mg/m³



8,3 kW



98 kg



12 Pa



78,2 %



0,060



580 mm



200 m³

EAN 5600863303895

TUGA







SALAMANDRAS A LENHA SEM VENTILAÇÃO

Estufas a lenha sin ventilación

SLDC c)







(canto/ rincón)

- 710 x 595 x 605 mm 
- 6 kW 
- 82,3 % 
- 98 | 116 | 21 mg/m³ 
- 0,063 
- 120 mm 
- 12 Pa 
- 63 kg 
- 320 mm 



ENTRADA DE AR EXTERIOR | Entrada de Aire Exterior

S800 c)

- 725 x 485 x 330 mm 
- 5,5 kW 
- 83,9 % 
- 152 | 24 | 35 mg/m³ 
- 0,041 
- 120 mm 
- 12 Pa 
- 70 kg 
- 320 mm 



ENTRADA DE AR EXTERIOR | Entrada de Aire Exterior

IRIS N990 c)

(com forno / con forno)
Medida Forno: 305 x 520 x 255 mm

- 955 x 555 x 390 mm 
- 8,5 kW 
- 88,2 % 
- 121 | 112 | 36 mg/m³ 
- 0,119 
- 120 mm 
- 12 Pa 
- 92 kg 
- 500 mm 



ENTRADA DE AR EXTERIOR | Entrada de Aire Exterior

SALAMANDRAS A LENHA SEM VENTILAÇÃO

Estufas a lenha sin ventilación



A+

SFF5 c)

(fundição / fundición)

604 x 454 x 337 mm

5 kW

80,5%

115 | 61 | 15 mg/m³

0,1

125 mm

12 Pa

71kg

300 mm

120 m³

ENTRADA DE AR EXTERIOR | Entrada de Aire Exterior



A

D10 c)

(fundição / fundición)

722 x 616 x 394 mm

10 kW

78,3%

80 | 59 | 34 mg/m³

0,059

150 mm

12 Pa

133 kg

430 mm

245 m³

ENTRADA DE AR EXTERIOR | Entrada de Aire Exterior

SALAMANDRAS A LENHA SEM VENTILAÇÃO

Estufas a leña sin ventilación

A+



1020 x 750 x 410 mm



150 mm



112 | 85 | 36 mg/m³



7,8 kW



130 kg



12 Pa



80,7 %



0,085



450 mm



190m³

EAN 5600863303574

X1



SALAMANDRAS A LENHA SEM VENTILAÇÃO









Estufas a lenha sin ventilación



EAN 5600863303284

A+

X1 BOX c)

-  1020 x 750 x 410 mm
-  7,8 kW
-  80,7%
-  112 | 85 | 36 mg/m³
-  0,085
-  150 mm
-  12 Pa
-  180kg
-  450 mm











ENTRADA DE AR EXTERIOR | Entrada de Aire Exterior 



EAN 5600863303277

A+

X1 SP c)

-  565 x 750 x 410 mm
-  7,8 kW
-  80,7%
-  112 | 85 | 36 mg/m³
-  0,085
-  150 mm
-  12 Pa
-  120kg
-  450 mm



ENTRADA DE AR EXTERIOR | Entrada de Aire Exterior 



MAXUS

 650 x 670 x 670 mm

 11,2 Kw

 80 mm

 130 kg

 91 %

 670gr-2060gr/h

 13 kg

 A+

 275 m³

EAN 5600863306742



RECUPERADORES AR QUENTE C/ VENTILAÇÃO PELLETS

Insertables a pellets con producción de aire caliente





MAXUS VITRUS

 650 x 775 x 670 mm

 11,2 Kw

 80 mm

 130 kg

 91 %

 670gr-2060gr/h

 13 kg

 A+

 275 m³

EAN 5600863307350



RECUPERADORES AR QUENTE C/ VENTILAÇÃO PELLETS

Insertables a pellets con producción de aire caliente



MAXUS HIDRO 900

 820 x 940 x 790 mm

 17,93 kW

 14,67 kW

 80 mm

 170 kg

 89,9 %

 1870gr~4080gr/h

 25 kg

 A+

 440 m³

EAN 5600863301174

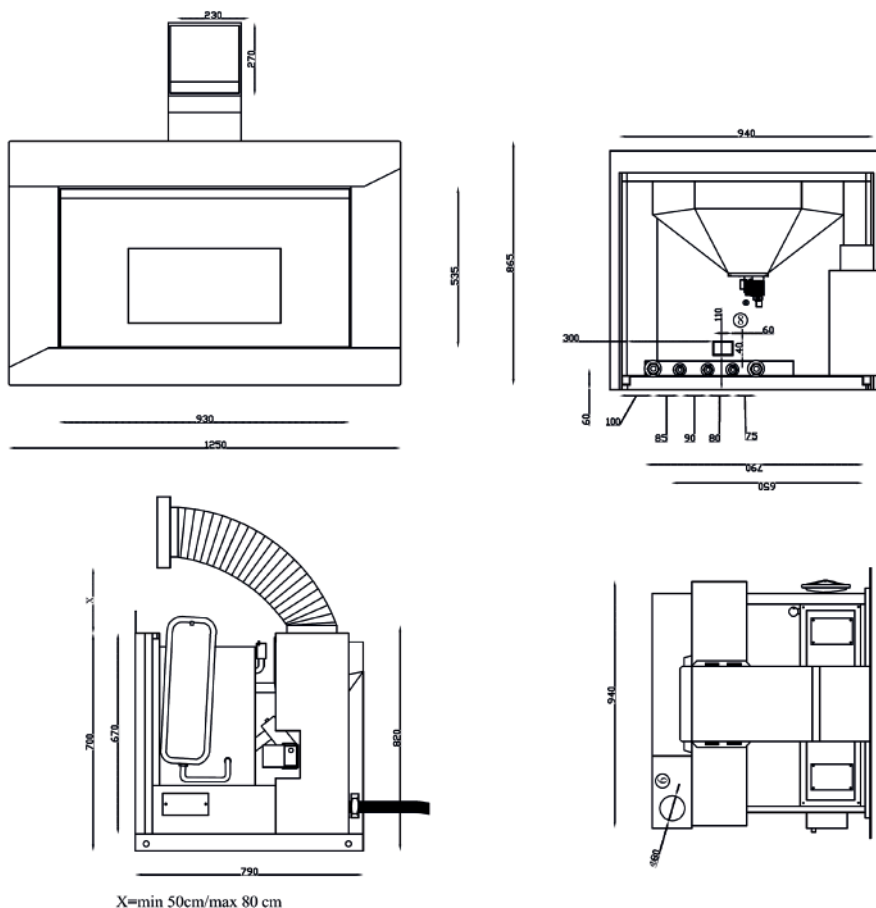

Estes equipamentos estão equipados com:

Bomba circuladora | Válvula de segurança de pressão | Termo hidrómetro-purgador automático | Programação automática | Acendimento automático Control de pressão e temperatura
Ligações hidráulicas em inox e latão | Corpo da caldeira em aço carbono | Silo em chapa galvanizada | Blindagens com pintura electrostática | Sensor de nível de pellets no silo
Possibilidade de ligação a termostato ambiente | Comando de válvula de 3 vias para AQS Dupla tentativa de ignição | Reacendimento depois de ter dado ordem de apagar | Avisos temporários de limpeza | Contadores horários.

Estos equipos están equipados con:

Bomba de circulación | Válvula de seguridad de presión | Término hidrómetro purgador automático | Programación automática | Encendido automático | Control de presión y temperatura
Conexiones hidráulicas de acero inoxidable y latón | Cuerpo de caldera de acero al carbono | Silo de chapa galvanizada | Escudos con pintura electro-óptica | Remitente de pellet nivel en el silo
Posibilidad de conexión a termostato ambiente | Control de válvula de 3 vias para ACS | Intento de doble encendido | Reavivar después de dar la orden de borrar | Avisos de limpieza temporal | Contadores de horas.



RECUPERADORES A PELLETS AQ. CENTRAL

Insert. a pellets hidro calefactor con prod. aire

MAXUS HIDRO 900

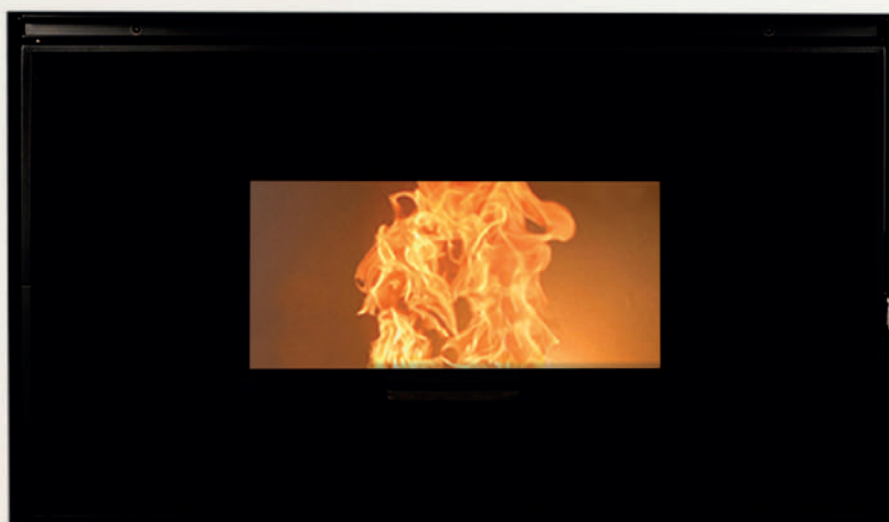

Com Aro em Aço de Série
Con Marco de Acero Estándar



Opção Aro Branco
Opción de Marco Blanco











Opção Aro Preto
Opción de Marco Negro





MAXUS HIDRO 20





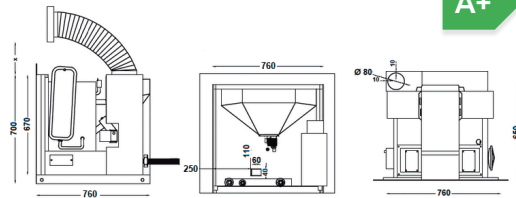



EAN 5600863307374

 750 x 770 x 770 mm	 150 kg
 17,93 kW	 1870gr-4080gr/h
 14,67 kW	 89,92 %
 80 mm	 20 kg



MAXUS HIDRO 25

EAN 5600863307381

 750 x 860 x 770 mm	 170 kg
 22,40 kW	 1870gr-5140gr/h
 18,4 kW	 88,90 %
 80 mm	 25 kg

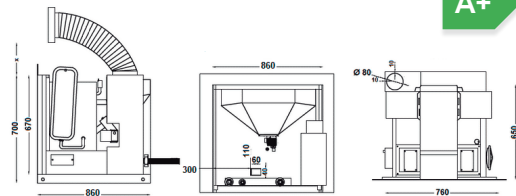

Estes equipamentos estão equipados com:

Bomba circuladora | Válvula de segurança de pressão | Termo hidrómetro-purgador automático | Programação automática | Acendimento automático | Control de pressão e temperatura | Ligações hidráulicas em inox e latão | Corpo da caldeira em aço carbono | Silo em chapa galvanizada | Blindagens com pintura electro-óptica | Sensor de nível de pellets no silo | Possibilidade de ligação a termostato ambiente | Comando de válvula de 3 vias para AQS Dupla tentativa de ignição | Reacendimento depois de ter dado ordem de apagar | Avisos temporários de limpeza | Contadores horários.

Estos equipos están equipados con:

Bomba de circulación | Válvula de seguridad de presión | Térmimo hidrómetro purgador automático | Programación automática | Encendido automático | Control de presión y temperatura | Conexiones hidráulicas de acero inoxidable y latón | Cuerpo de caldera de acero al carbono | Silo de chapa galvanizada | Escudos con pintura electro-óptica | Remitente de pellet nivel en el silo | Posibilidad de conexión a termostato ambiente | Control de válvula de 3 vias para ACS | Intento de doble encendido | Reavivar después de dar la orden de borrar | Avisos de limpieza temporal | Contadores de horas.

RECUPERADORES A PELLETS AR QUENTE E AQ. CENTRAL
Insert. a pellets hidro calefactor con prod. aire caliente

MAXUS HIDRO



SALAMANDRAS A PELLETS - AR QUENTE

Estufas a pellets - aire caliente

A+



1105 x 820 x 290 mm



80 mm



90,2 %



10 Kw



95 kg



15 kg



900gr-2260gr/h



0,8A-2,5A

Cores Disponíveis:
Cores Disponíveis:



245 m³

(BRANCO) EAN 5600863303185

(PRETO) EAN 5600863303178

SLIM CRISTAL

(canalizável/ canalizable)



SALAMANDRAS A PELLETS - AR QUENTE









Estufas a pellets - aire caliente

(PRETO) EAN 5600863300351
(CREME) EAN 5600863300368



A+

SLIM
(canalizável/ canalizable)

-  883 x 960 x 290 mm
-  10,6 Kw
-  80 mm
-  140 kg
-  700gr~2600gr/h
-  0,8A-2,5A
-  87,3 %
-  15 kg

Cores Disponíveis:
Cores Disponíveis:











(PRETO) EAN 5600863303086
(BRANCO) EAN 5600863303093



A+

SLIM DESIGN 22
(canalizável/ canalizable)

-  877 x 955 x 290 mm
-  10,6 Kw
-  80 mm
-  140 kg
-  700gr~2600gr/h
-  0,8A-2,5A
-  87,3 %
-  15 kg

Cores Disponíveis:
Cores Disponíveis:



(PRETO) EAN 5600863301365
(BRANCO) EAN 5600863301372



A+

SLIMMY

-  885 x 800 x 281 mm
-  10,6 Kw
-  80 mm
-  130 kg
-  700gr~2600gr/h
-  0,8A-2,5A
-  87,3 %
-  15 kg

Cores Disponíveis:
Cores Disponíveis:



SALAMANDRAS A PELLETS - AR QUENTE

Estufas a pellets - aire caliente

NOA

955 x 530 x 530 mm 

11 Kw 

80 mm 

110 kg 

900gr-2600gr/h 

0,8A-2,5A 

87,6 % 

18 kg 

Cores Disponíveis:
Cores Disponíveis:



A+



(PRETO) EAN 5600863301280
(BRANCO) EAN 5600863301297



270 m3

VICENTINA QUATTRO

1010 x 480 x 550 mm 

9,6 Kw 

80 mm 

118 kg 

760gr-2160gr/h 

0,8A-2,5A 

90 % 

15 kg 

Cores Disponíveis:
Cores Disponíveis:



A+



(PRETO) EAN 5600863300870 (BRANCO) EAN 5600863300887 (BRONZE) EAN 5600863300894



235 m3

BÁRBARA

963 x 480 x 530 mm 

11 Kw 

80 mm 

145 kg 

800gr-2600gr/h 

0,8A-2,5A 

87,6 % 

18 kg 

Cores Disponíveis:
Cores Disponíveis:



A+



(PRETO) EAN 5600863301792 (BRANCO) EAN 5600863301785 (BORDEAUX) EAN 5600863301808



270 m3





SALAMANDRAS A PELLETS - AR QUENTE

Estufas a pellets - aire caliente



(PRETO) EAN 5600863303147 (BRANCO) EAN 5600863303154 (BRONZE) EAN 5600863303161

ADRIANA 8 CRISTAL





-  920 x 495 x 560 mm
-  8,2 Kw
-  80 mm
-  108 kg
-  600gr-1900gr/h
-  0,8A-2,5A
-  87 %
-  15 kg

Cores Disponíveis:
Cores Disponíveis:



(PRETO) EAN 5600863300849 (BRANCO) EAN 5600863300856 (BRONZE) EAN 5600863300863

ADRIANA 8



-  920 x 495 x 560 mm
-  8,2 Kw
-  80 mm
-  108 kg
-  600gr-1900gr/h
-  0,8A-2,5A
-  87 %
-  15 kg

Cores Disponíveis:
Cores Disponíveis:



(PRETO) EAN 5600863307503 (BRANCO) EAN 5600863307510 (BRONZE) EAN 5600863307527

ADRIANA 6 CRISTAL

-  875 x 452 x 570 mm
-  6,5 Kw
-  80 mm
-  75 kg
-  600gr-1600gr/h
-  0,8A-2,5A
-  86 %
-  15 kg

Cores Disponíveis:
Cores Disponíveis:



SALAMANDRAS A PELLETS - AR QUENTE

Estufas a pellets - aire caliente

ADRIANA 6

875 x 452 x 570 mm



6,5 Kw



80 mm



75 kg



600gr-1600gr/h



0,8A-2,5A



86 %



15 kg



Cores Disponiveis:
Cores Disponibles:



(PRETO) EAN 5600863300290 (BRANCO) EAN 5600863302966 (BRONZE) EAN 5600863302973

ISABEL ECO

920 x 510 x 560 mm



8,2 Kw



80 mm



108 kg



600gr-1900gr/h



0,8A-2,5A



87 %



15 kg



Cores Disponiveis:
Cores Disponibles:



(PRETO) EAN 5600863305899 (GRIZ) EAN 5600863305912 (BORDEAUX) EAN 5600863305905

ISABEL

920 x 510 x 560 mm



8,2 Kw



80 mm



108 kg



600gr-1900gr/h



0,8A-2,5A



87 %



15 kg



Cores Disponiveis:
Cores Disponibles:











(PRETO) EAN 5600863304403

A+

Cores Disponíveis:
Cores Disponíveis:











AMIGA 8

955 x 471 x 495 mm  7,4 Kw 
92,1 %  80 mm 
840gr-1650gr/h  95 kg 
0,8A-2,5A  10 kg 



(PRETO) EAN 5600863301976
(BRANCO) EAN 5600863301983
(BORDEAUX) EAN 5600863301990









AMIGA 10

1090 x 522 x 540 mm  9,2 Kw 
92,2 %  80 mm 
840gr-2040gr/h  100 kg 
0,8A-2,5A  10 kg 



(PRETO) EAN 5600863302003
(BRANCO) EAN 5600863302010
(BORDEAUX) EAN 5600863302027

AMIGA 12

1190 x 522 x 540 mm  12 Kw 
92,4 %  80 mm 
840gr-2450gr/h  110 kg 
0,8A-2,5A  10 kg 











(PRETO) EAN 5600863303116
(BRANCO) EAN 5600863303123
(BORDEAUX) EAN 5600863303130





SLIM HIDRO 20 d)









 1140 x 935 x 390 mm	 1650gr~4390gr/h
 20 Kw	 50 L
 16 Kw	 93 %
 80 mm	 22 kg
 180 kg	

A+

 490 m³

(PRETO) EAN 5600863301730 (BRANCO) EAN 5600863301747

SLIM HIDRO 28 d)

 1160 x 985 x 440 mm	 1650gr~5920gr/h
 26,2 Kw	 55 L
 21,7 Kw	 90,4 %
 100 mm	 25 kg
 190 kg	

A+

 640 m³

(PRETO) EAN 5600863301754 (BRANCO) EAN 5600863301761

Cores Disponíveis:
Colores Disponibles:



d) Equipada de série com:
Bomba circuladora | Caldeira com corpo em aço carbono | Queimador em aço inox | Centralina Tiemme | Resistência cerâmica
Vaso expansão 5L | Válvula de pressão de 3Kg | Fácil programação e limpeza

h) Equipada de serie con:
Bomba de circulación | Caldera de cuerpo de acero al carbono | Quemador de acero inoxidable | Centralita Tiemme | Resistencia cerámica
Vaso de expansión 5L | Válvula de presión de 3 kg | Fácil programación y limpieza









SALAMANDRA A PELLETS - HIDROESTUFAS

Hidro-Estufas a pellets - aire caliente





CRISTAL 18 d)

 1127 x 584 x 631 mm	 1000gr-4000gr/h
 18 Kw	 41 L
 17 Kw	 94,7 %
 80 mm	 30 kg
 175 kg	









A++



Dupla porta, frente em vidro temperado preto
Puerta doble, frente de vidrio templado negro

(PRETO) EAN 5600863302362 (BRANCO) EAN 5600863302379

CRISTAL 24 d)

 1127 x 584 x 631 mm	 1300gr-5000gr/h
 24 Kw	 48 L
 23 Kw	 94,5 %
 80 mm	 30 kg
 192 kg	

A++



Dupla porta, frente em vidro temperado preto
Puerta doble, frente de vidrio templado negro

(PRETO) EAN 5600863302386 (BRANCO) EAN 5600863302393

Cores Disponíveis:
Colores Disponibles:



d) Equipada de série com:

Bomba circuladora | Caldeira com corpo em aço carbono | Queimador em aço inox | Centralina Tiemme | Resistência cerâmica
Vaso expansão 5L | Válvula de pressão de 3Kg | Fácil programação e limpeza

h) Equipada de serie con:

Bomba de circulación | Caldera de cuerpo de acero al carbono | Quemador de acero inoxidable | Centralita Tiemme | Resistencia cerâmica
Vaso de expansión 5L | Válvula de presión de 3 kg | Fácil programación y limpieza













CALDEIRAS A PELLETS

Calderas a pellets



CPC18 d)











 960 x 581 x 608 mm	 90 °C
 18 kW	 41 L
 17 Kw	 94,3 %
 175 kg	 1-4 Kg/h
 80 mm	 30 kg

A++



EAN 5600863306926

CPC24 d)









 1040 x 581 x 608 mm	 90 °C
 24 kW	 48 L
 23 Kw	 93,7 %
 192 kg	 1,3-5 Kg/h
 80 mm	 30 kg

A++



EAN 5600863306841

CPC30 d)

 1091 x 621 x 650 mm	 90 °C
 30 kW	 55 L
 29 Kw	 91,8 %
 210 kg	 1,6-6 Kg/h
 80 mm	 35 kg

A+



EAN 5600863306858

d) Equipada de série com:
Bomba circuladora | Caldeira com corpo em aço carbono | Queimador em aço inox | Centralina Tiemme | Resistência cerâmica
Vaso expansão 5L | Válvula de pressão de 3Kg | Fácil programação e limpeza

h) Equipada de serie con:
Bomba de circulación | Caldera de cuerpo de acero al carbono | Quemador de acero inoxidable | Centralita Tiemme | Resistencia cerâmica
Vaso de expansión 5L | Válvula de presión de 3 kg | Fácil programación y limpieza

CALDEIRAS A PELLETS

Calderas a pellets







CPC 18



NOVA 25

(SEMI-AUTOMÁTICA)









-  1290 x 605 x 875 mm
-  25,5 Kw
-  25,5 Kw
-  100 mm
-  265 kg
-  2100gr-5700gr/h
-  35 L
-  91,7 %
-  50 kg



EAN 5600863301198

NOVA 35

(SEMI-AUTOMÁTICA)

-  1390 x 665 x 820 mm
-  31,7 Kw
-  31,7 Kw
-  100 mm
-  330 kg
-  2100gr-7000gr/h
-  35 L
-  92,3 %
-  70 kg



EAN 5600863301181

NOTA: Equipamento com limpeza automática e aspiração de cinzas
Nota: Equipo con limpieza automática y aspiración de cenizas

CALDEIRAS A PELLETS

Calderas a pellets

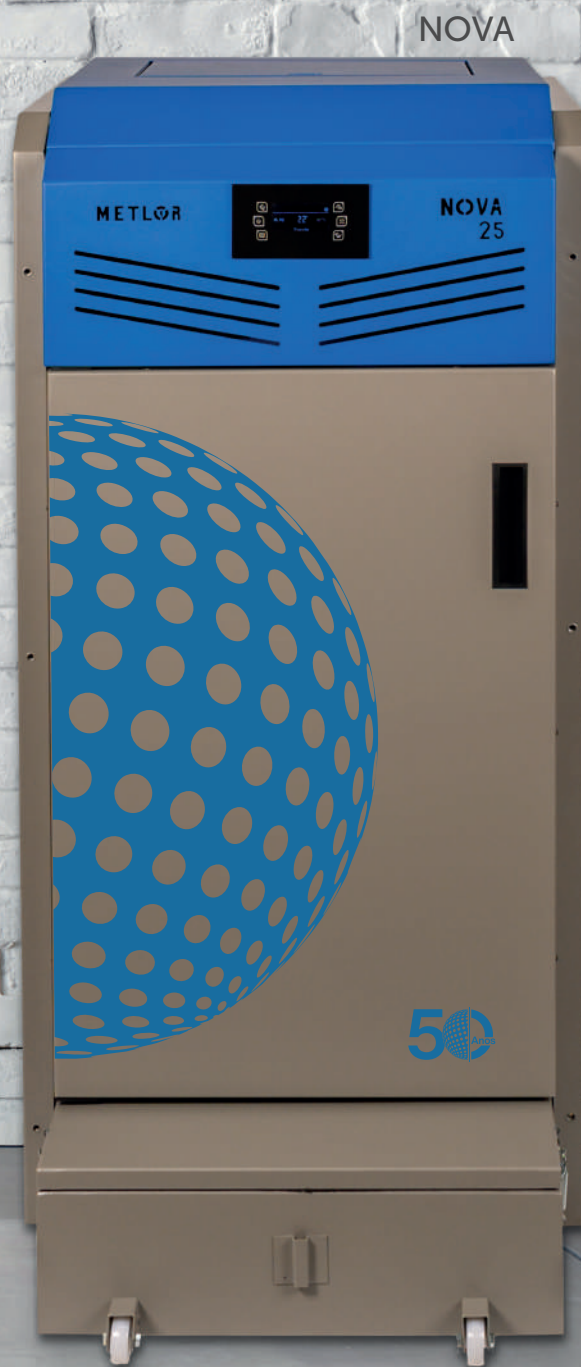

Estes equipamentos estão equipados com:









Bomba circuladora | Válvula de segurança de pressão | Termo hidrómetro-purgador automático | Programação automática | Acendimento automático | Controlo de pressão e temperatura | Ligações hidráulicas em inox e latão | Corpo da caldeira em aço carbono | Silo em chapa galvanizada | Blindagens com pintura electrostática | Sensor de nível de pellets no silo | Possibilidade de ligação a termostato ambiente | Comando de válvula de 3 vias para AQS | Dupla tentativa de ignição | Reacendimento depois de ter dado ordem de apagar | Avisos temporários de limpeza | Contadores horários.

Estos equipos están equipados con:

Bomba de circulación | Válvula de seguridad de presión | Término hidrómetro purgador automático | Programación automática | Encendido automático | Control de presión y temperatura | Conexiones hidráulicas de acero inoxidable y latón | Cuerpo de caldera de acero al carbono | Silo de chapa galvanizada | Escudos con pintura electro-óptica | Remitente de pellet nivel en el silo | Posibilidad de conexión a termostato ambiente | Control de válvula de 3 vías para ACS | Intento de doble encendido | Reavivar después de dar la orden de borrar | Avisos de limpieza temporal | Contadores de horas.



CEC 18 d)









 1395 x 566 x 787 mm	 90 °C
 18,79 Kw	 48 L
 220 kg	 94,8 %
 80 mm	 1-4 Kg/h
	 100 kg

A++



EAN 5600863307237

CEC 24 d)







 1395 x 566 x 787 mm	 90 °C
 24,14 Kw	 48 L
 220 kg	 94,6 %
 80 mm	 1-4 Kg/h
	 100 kg

A++



EAN 5600863307244

CEC 35 d)

 1500 x 626 x 788 mm	 90 °C
 36,62 Kw	 65 L
 240 kg	 94,8 %
 80 mm	 1-4 Kg/h
	 70 kg

A++



EAN 5600863307244

d) Equipada de série com:

Bomba circuladora | Caldeira com corpo em aço carbono | Queimador em aço inox | Centralina Tiemme | Resistência cerâmica
Vaso expansão 5L | Válvula de pressão de 3Kg | Fácil programação e limpeza

h) Equipada de serie con:

Bomba de circulación | Caldera de cuerpo de acero al carbono | Quemador de acero inoxidable | Centralita Tiemme | Resistencia cerâmica
Vaso de expansión 5L | Válvula de presión de 3 kg | Fácil programación y limpieza

CALDEIRA A PELLETS

Caldera a pellets

LIMPEZA MANUAL
Limpieza Manual





CEC 18 PRO AUTO d)

1465x 600 x 795 mm	90 °C
18,26 Kw	38 L
310 kg	95,5 %
80 mm	1-4 Kg/h
	100 kg



EAN 5600863300832

CEC 24 PRO AUTO d)

1565 x 680 x 795 mm	90 °C
24,11 Kw	50 L
350 kg	94,1 %
80 mm	1-4 Kg/h
	100 kg



EAN 5600863300825

CEC 35 PRO AUTO d)

1565 x 680 x 795 mm	90 °C
35,68 Kw	50 L
350 kg	94,8 %
100 mm	1-4 Kg/h
	100 kg



EAN 5600863300795

CEC 50 PRO AUTO d)

1615 x 808 x 861 mm	90 °C
50 Kw	86 L
445 kg	>96 %
100 mm	1-4 Kg/h
	130 kg



EAN 5600863302805

d) Equipada de série com:

Bomba circuladora | Caldeira com corpo em aço carbono | Queimador em aço inox | Centralita Tiemme | Resistência cerâmica
Vaso expansão 5L | Válvula de pressão de 3Kg | Fácil programação e limpeza

h) Equipada de serie con:

Bomba de circulación | Caldera de cuerpo de acero al carbono | Quemador de acero inoxidable | Centralita Tiemme | Resistencia cerámica
Vaso de expansión 5L | Válvula de presión de 3 kg | Fácil programación y limpieza

CALDEIRA A PELLETS

Caldera a pellets

LIMPEZA AUTOMÁTICA
Limpieza Automática





POLICOMBUSTÍVEL 30

- 1415 x 1256 x 955 mm
- 1000gr-4000gr/h
- 30 Kw
- 73 L
- 180 mm
- 90,9 %
- 510 kg
- 200 kg
- 330 mm



EAN 5600863301648

POLICOMBUSTÍVEL 40

- 1415 x 1306 x 955 mm
- 1000gr-4000gr/h
- 40 Kw
- 95 L
- 180 mm
- 90,%
- 530 kg
- 200 kg
- 330 mm



EAN 5600863301631

LENHA

PELLETS

GAROÇO DE AZEITONA

CASCA DE AMÊNDOA



CALDEIRA POLICOMBUSTÍVEL

Caldera Policombustible





CL25 PYRO EVOLUTION

(chama invertida/ llama invertida)

 1425 x 595 x 1175 mm	 90 °C
 25 Kw	 87 L
 465 kg	 91 %
 160 mm	 500 mm







A+



EAN 5600863301150

CL40 PYRO EVOLUTION

(chama invertida/ llama invertida)

 1545 x 595 x 1175 mm	 90 °C
 40 Kw	 124 L
 580 kg	 91 %
 160 mm	 500 mm

A+



EAN 5600863301167

CALDEIRAS A LENHA

Calderas a leña

CL25 PYRO EVOLUTION



FOGÕES TRADICIONAIS

Cocinas Tradicionales

EAN 5600863305714



ME16 Inox

A

Saída de fumos do lado direito ou do lado esquerdo (opcional)
Salida de humos lateral derecha o izquierda (opcional)

POTÊNCIA: 6,4 kW
RENDIMENTO: 77%
ALTURA: 820 mm
LARGURA: 935 mm
PROFUNDIDADE: 545 mm

FORNO: 280 x 415 x 460 mm
FORNALHA: 320 x 220 x 440 mm
SAÍDA DE FUMOS: 150 mm
COMP. MAX. DE LENHA: 400 mm



155 m³

FOGÕES TRADICIONAIS

Cocinas Tradicionales

ME16 BLACK

A

EAN 5600863302164

POTÊNCIA: 6,4 kW
RENDIMENTO: 77%
ALTURA: 820 mm
LARGURA: 935 mm
PROFUNDIDADE: 545 mm
FORNO: 280 x 415 x 460 mm
FORNALHA: 320 x 220 x 440 mm
SAÍDA DE FUMOS: 150 mm
COMP. MAX. DE LENHA: 400 mm

Saída de fumos do lado direito ou do lado esquerdo (opcional)
Salida de humos lateral derecha o izquierda (opcional)



155 m³



ME700

A+

EAN 5600863300207

POTÊNCIA: 8,9 kW
RENDIMENTO: 81%
ALTURA: 825 mm
LARGURA: 830 mm
PROFUNDIDADE: 535 mm
FORNO: 280 x 370 x 470 mm
FORNALHA: 300 x 200 x 470 mm
SAÍDA DE FUMOS: 150 mm
COMP. MAX. DE LENHA: 400 mm

Saída de fumos do lado direito ou do lado esquerdo (opcional)
Salida de humos lateral derecha o izquierda (opcional)



215 m³



ME70

A+

EAN 5600863305462

POTÊNCIA: 8,9 kW
RENDIMENTO: 81%
ALTURA: 825 mm
LARGURA: 830 mm
PROFUNDIDADE: 535 mm
FORNO: 280 x 370 x 470 mm
FORNALHA: 300 x 200 x 470 mm
SAÍDA DE FUMOS: 150 mm
COMP. MAX. DE LENHA: 400 mm

Saída de fumos do lado direito ou do lado esquerdo (opcional)
Salida de humos lateral derecha o izquierda (opcional)



215 m³



FOGÕES TRADICIONAIS

Cocinas Tradicionales

EAN 5600863300511



A+

ME130

POTÊNCIA: 8,9 kW
RENDIMENTO: 81%
ALTURA: 825 mm
LARGURA: 935 mm
PROFUNDIDADE: 535 mm
FORNO: 280 x 475 x 470 mm
FORNALHA: 300 x 200 x 470 mm
SAÍDA DE FUMOS: 150 mm
COMP. MAX. DE LENHA: 400 mm



Saída de fumos do lado direito ou do lado esquerdo (opcional)
Salida de humos lateral derecha o izquierda (opcional)

EAN 5600863305493



A+

ME50

POTÊNCIA: 8,9 kW
RENDIMENTO: 81%
ALTURA: 825 mm
LARGURA: 935 mm
PROFUNDIDADE: 535 mm
FORNO: 280 x 370 x 470 mm
FORNALHA: 300 x 200 x 470 mm
SAÍDA DE FUMOS: 150 mm
COMP. MAX. DE LENHA: 400 mm



Saída de fumos do lado direito ou do lado esquerdo (opcional)
Salida de humos lateral derecha o izquierda (opcional)

EAN 5600863305769



FORNO A LENHA OUTDOOR

P/ Churrasqueira

ALTURA: 500 mm
LARGURA: 1140 mm
PROFUNDIDADE: 555 mm
FORNO: 340 x 730 x 500 mm
FORNALHA: 165 x 185 x 490 mm
SAÍDA DE FUMOS: 150 mm
COMP. MAX. DE LENHA: 480 mm

Saída de fumos do lado direito ou do lado esquerdo (opcional)
Salida de humos lateral derecha o izquierda (opcional)

NOTAS

Notas

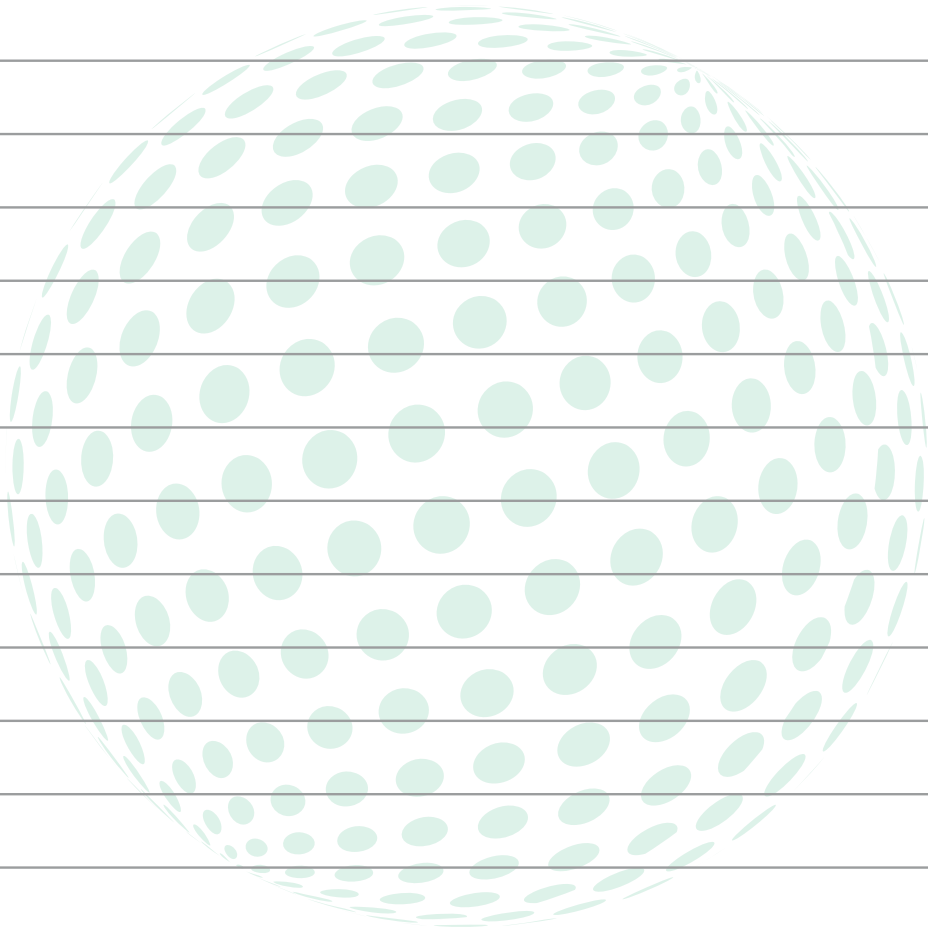

NOTAS
Notas

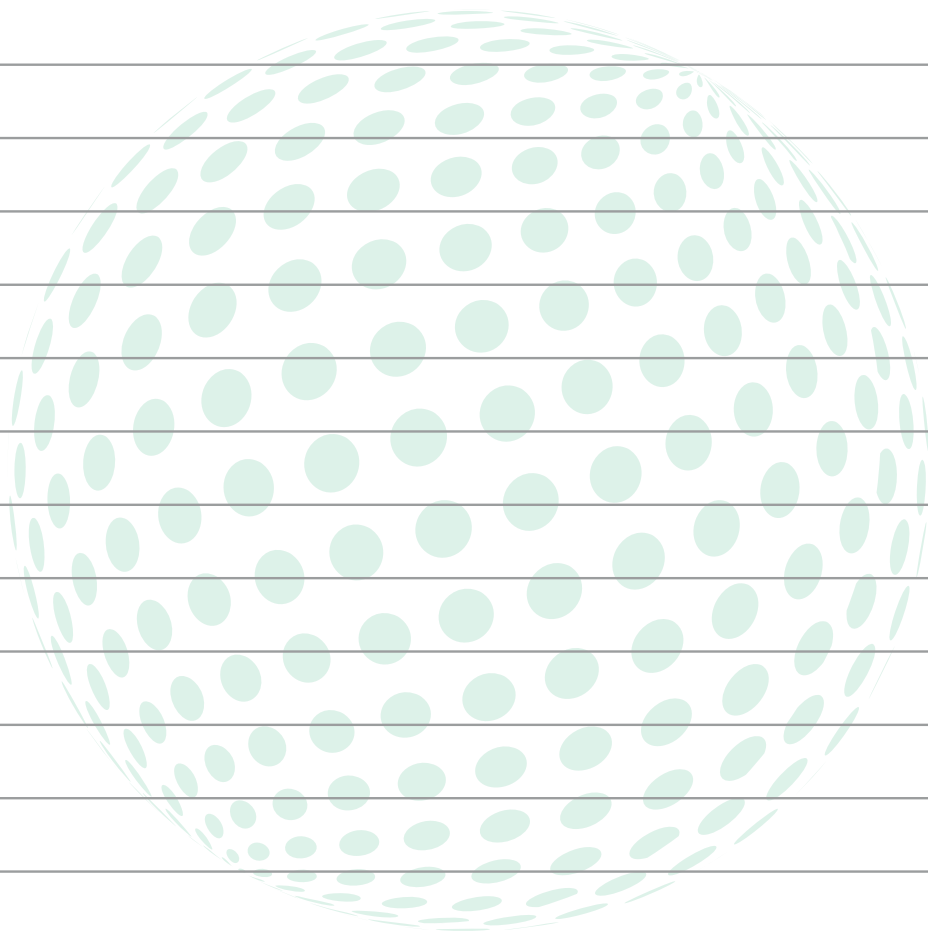

METLOR[®]
puro calor

Soluções Globais de Aquecimento

Soluciones Globales para Calefacción

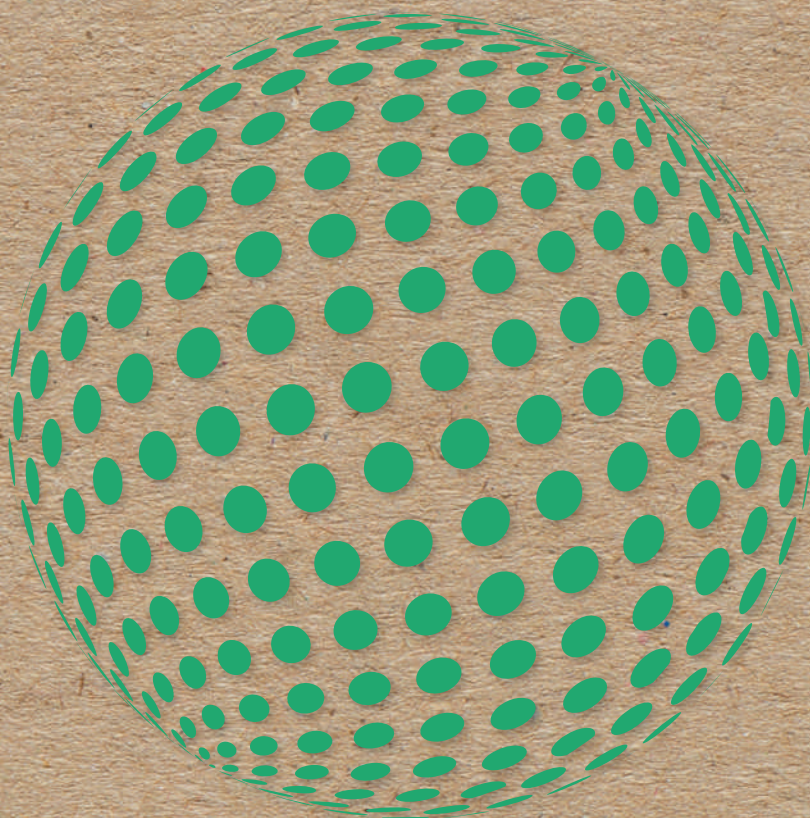

metlor.com

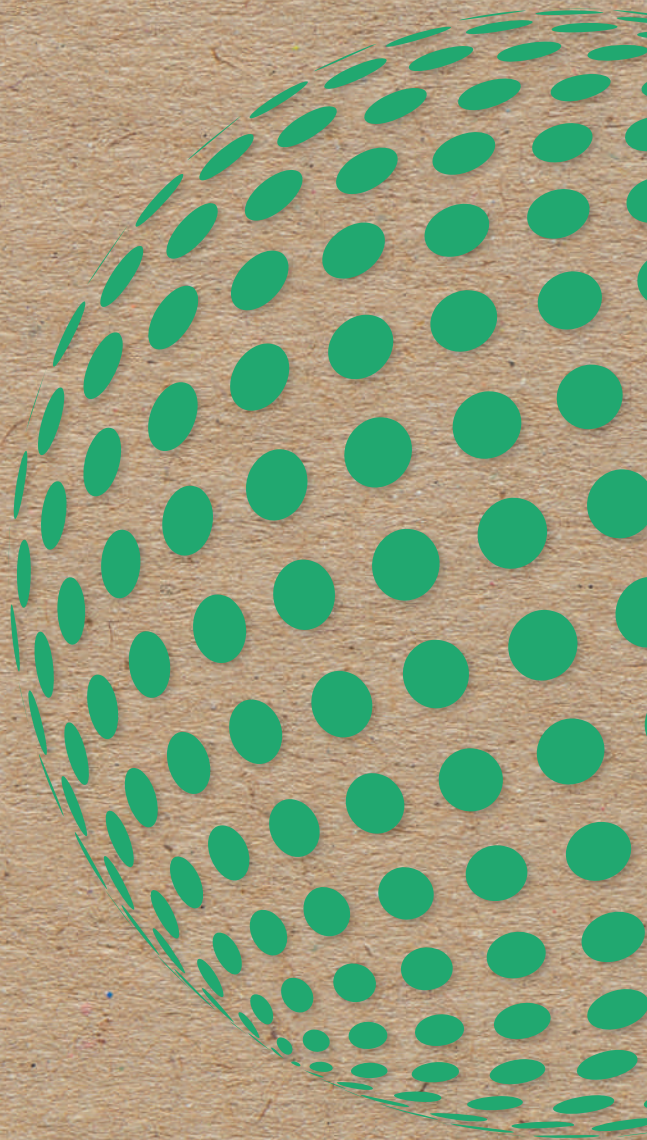

METLOR[®]
puro calor

Metalúrgica do Eucalipto
Rua Corredoura - Nesprido
3505 - 246 - Viseu
T +351. 232 931 171 | F +351. 232 931 545
geral@metlor.com | www.metlor.com

 **GRUPO
METLOR**
Since 1970

50 Anos

EUCALIPTO